

NAZWA PROJEKTU / PROJECT TITLE:

PIASECZNO

TYTUŁ RYSUNKU / DRAWING TITLE:

**UNITS DIVISION
OFFICE AND SOCIAL AREA
UNIT 4- FIT-OUT**

DATA / DATE:





09.2025

ZM. / REV.:

18

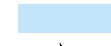
Unit 4
social and office rooms
ground floor: 15,02 m² + 6,82 m²
first floor: 174,40 m²
(part of shared staircase: 18,39 m²)

LEGEND:

-  office and social area for unit
-  staircase shared by units
-  main entrances
-  dock gate
-  drive-in gate
-  main entrance

LOCATION SCHEME

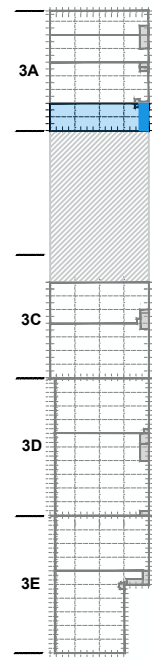

DRAWING SCALE



WARNING!
CONCEPT DRAWING - MAY BE SUBJECT TO CHANGE AT
THE STAGE OF THE CONSTRUCTION PROJECT

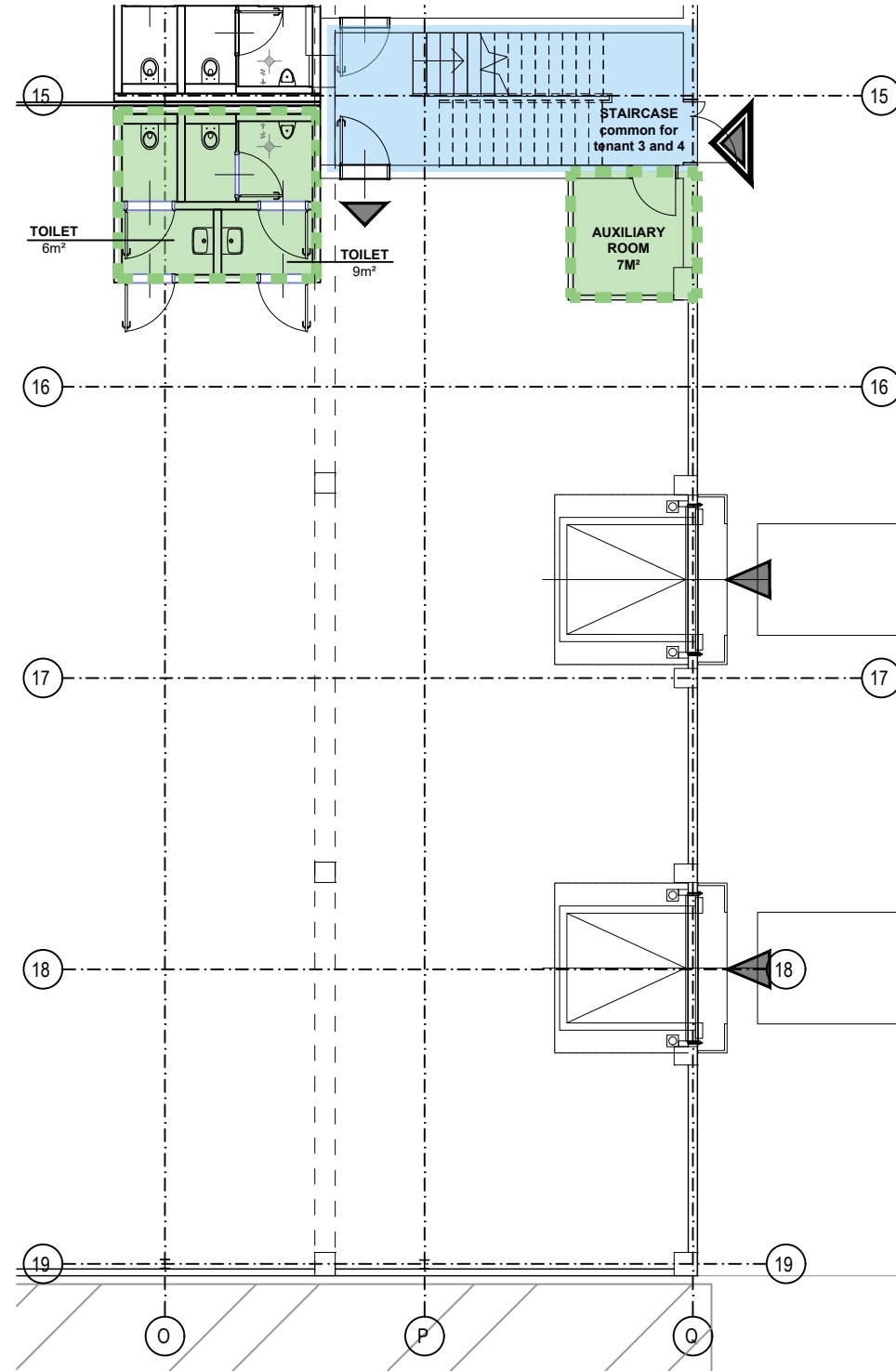

GROUND FLOOR

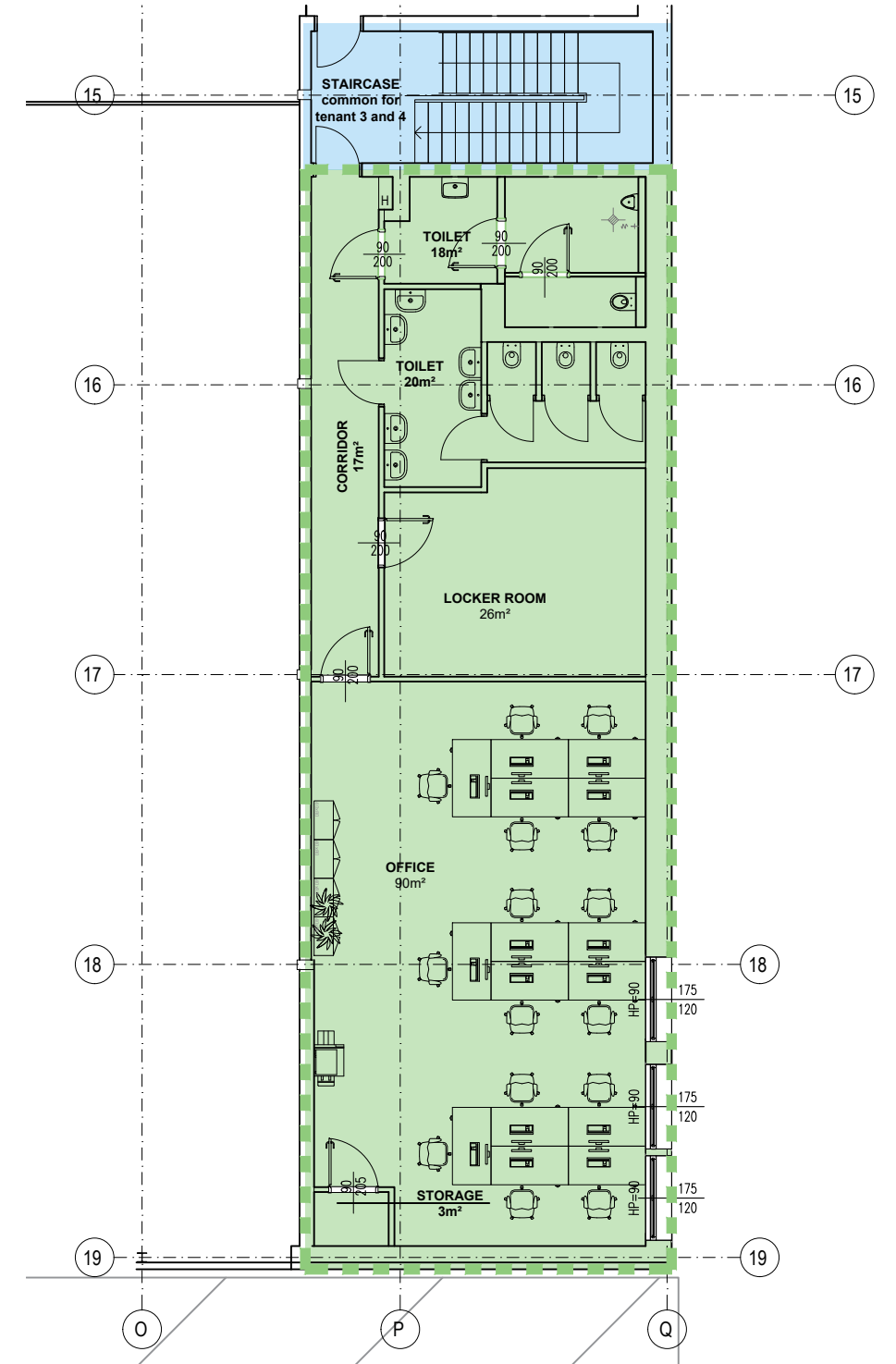

FIRST FLOOR

NAZWA PROJEKTU / PROJECT TITLE:

PIASECZNO

TYTUŁ RYSUNKU / DRAWING TITLE:

**UNITS DIVISION
OFFICE AND SOCIAL AREA
UNIT 4- FIT-OUT**

DATA / DATE:





09.2025

ZM. / REV.:

18

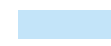
Unit 4
social and office rooms
ground floor: 15,02 m² + 6,82 m²
first floor: 174,40 m²
(part of shared staircase: 18,39 m²)

LEGEND:

-  office and social area for unit
-  staircase shared by units
-  main entrances
-  dock gate
-  drive-in gate
-  main entrance

LOCATION SCHEME

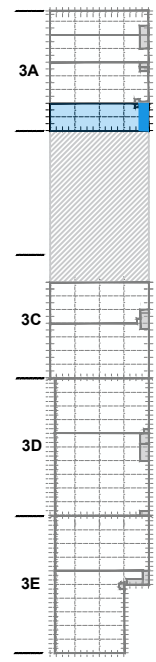

DRAWING SCALE

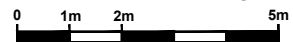

WARNING!
CONCEPT DRAWING - MAY BE SUBJECT TO CHANGE AT
THE STAGE OF THE CONSTRUCTION PROJECT

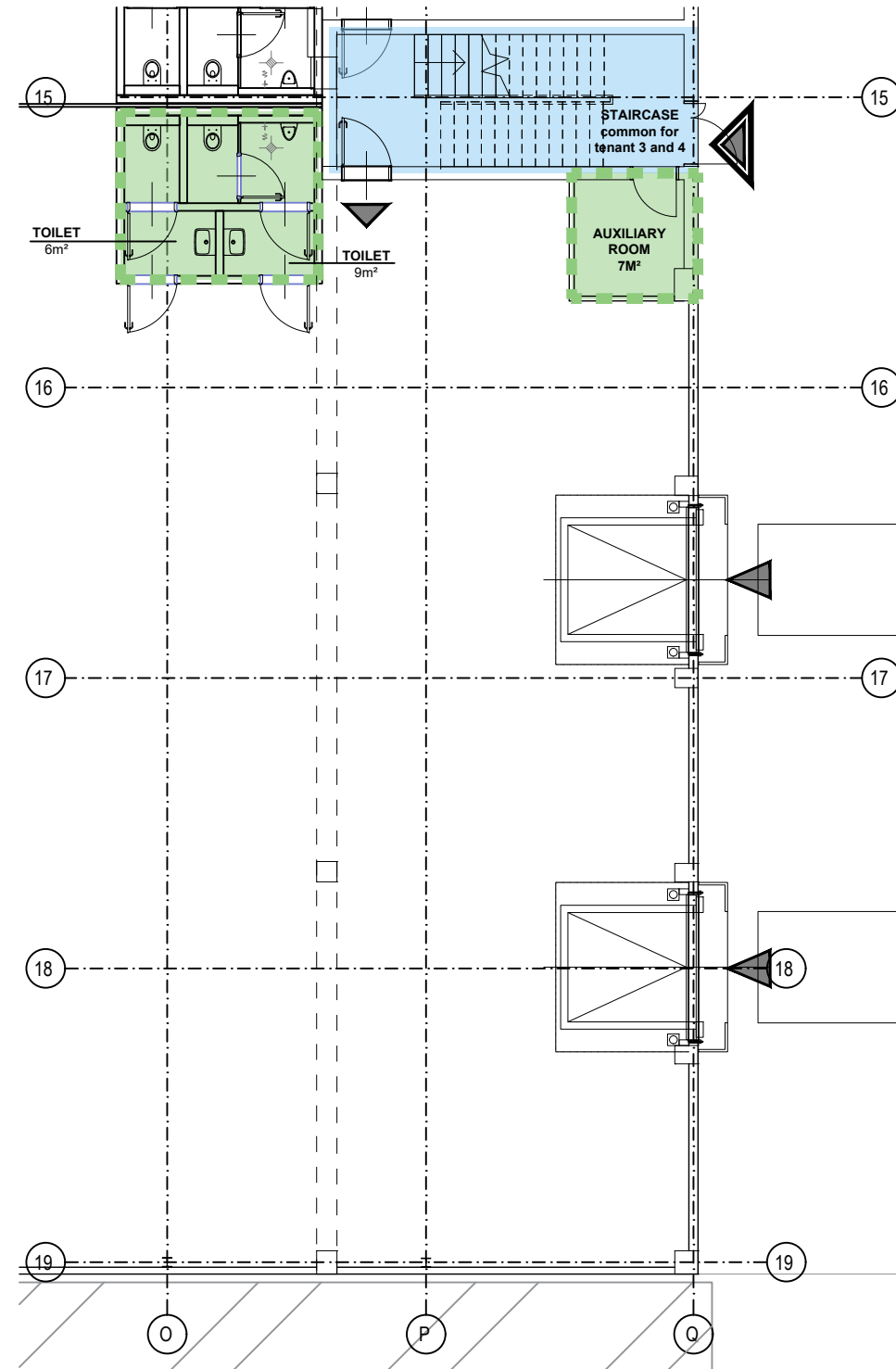

GROUND FLOOR

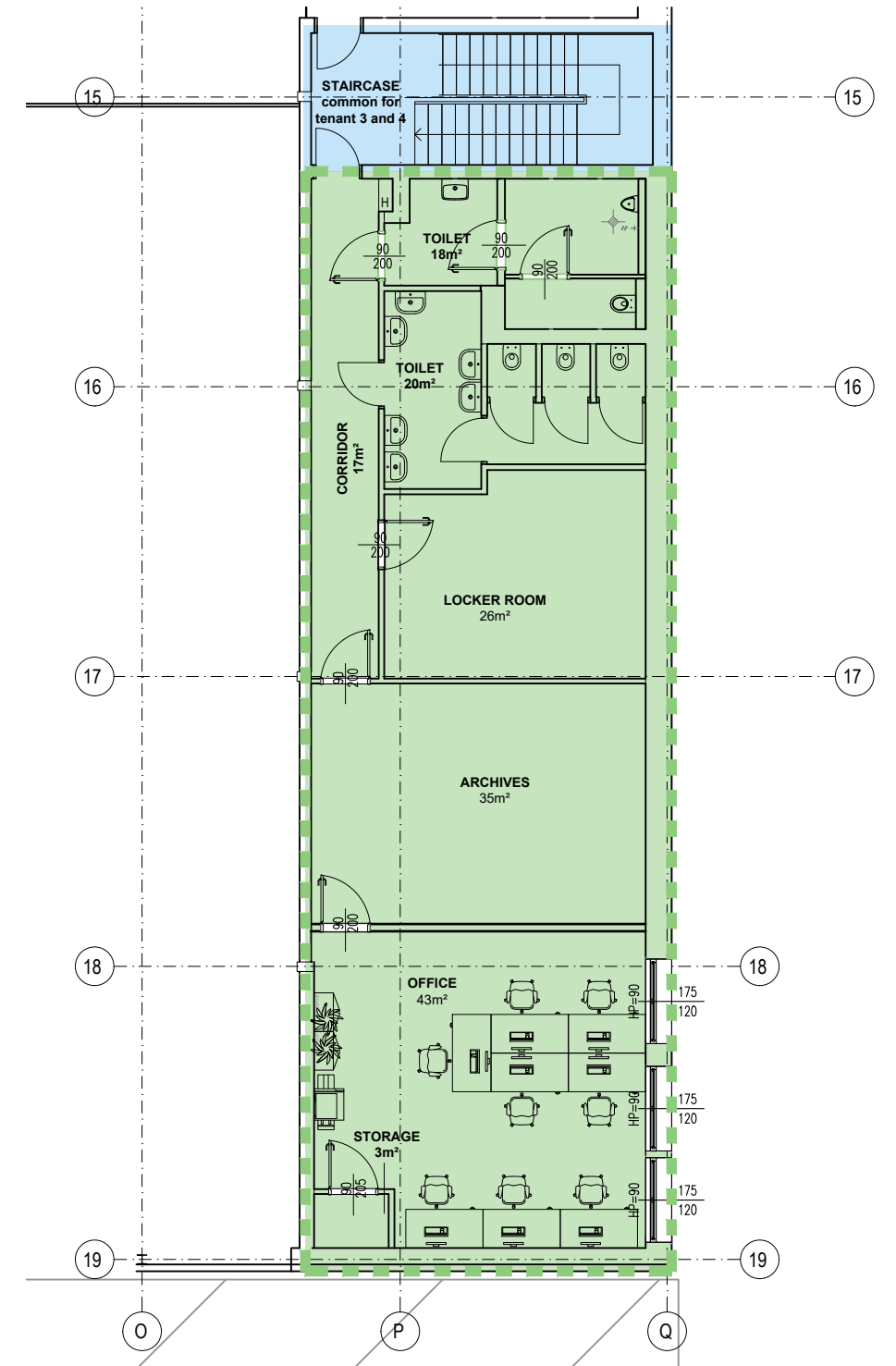

FIRST FLOOR