

NAZWA PROJEKTU / PROJECT TITLE:

PIASECZNO

TYTUŁ RYSUNKU / DRAWING TITLE:

**UNITS DIVISION
OFFICE AND SOCIAL AREA
UNIT 3- FIT-OUT**

DATA / DATE:





11.2025

ZM. / REV.:

18

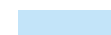
Unit 3
social and office space
ground floor: 25,73 m² + 15,10 m²
first floor: 266,95 m² as a mezzanine
(part of shared staircase: 28,16 m²)

LEGEND:

-  office and social area for unit
-  staircase shared by units
-  main entrances
-  dock gate
-  drive-in gate
-  main entrance

LOCATION SCHEME

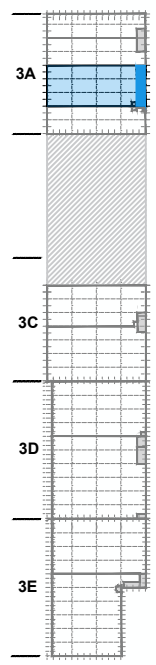

DRAWING SCALE



WARNING!
CONCEPT DRAWING - MAY BE SUBJECT TO CHANGE AT
THE STAGE OF THE CONSTRUCTION PROJECT

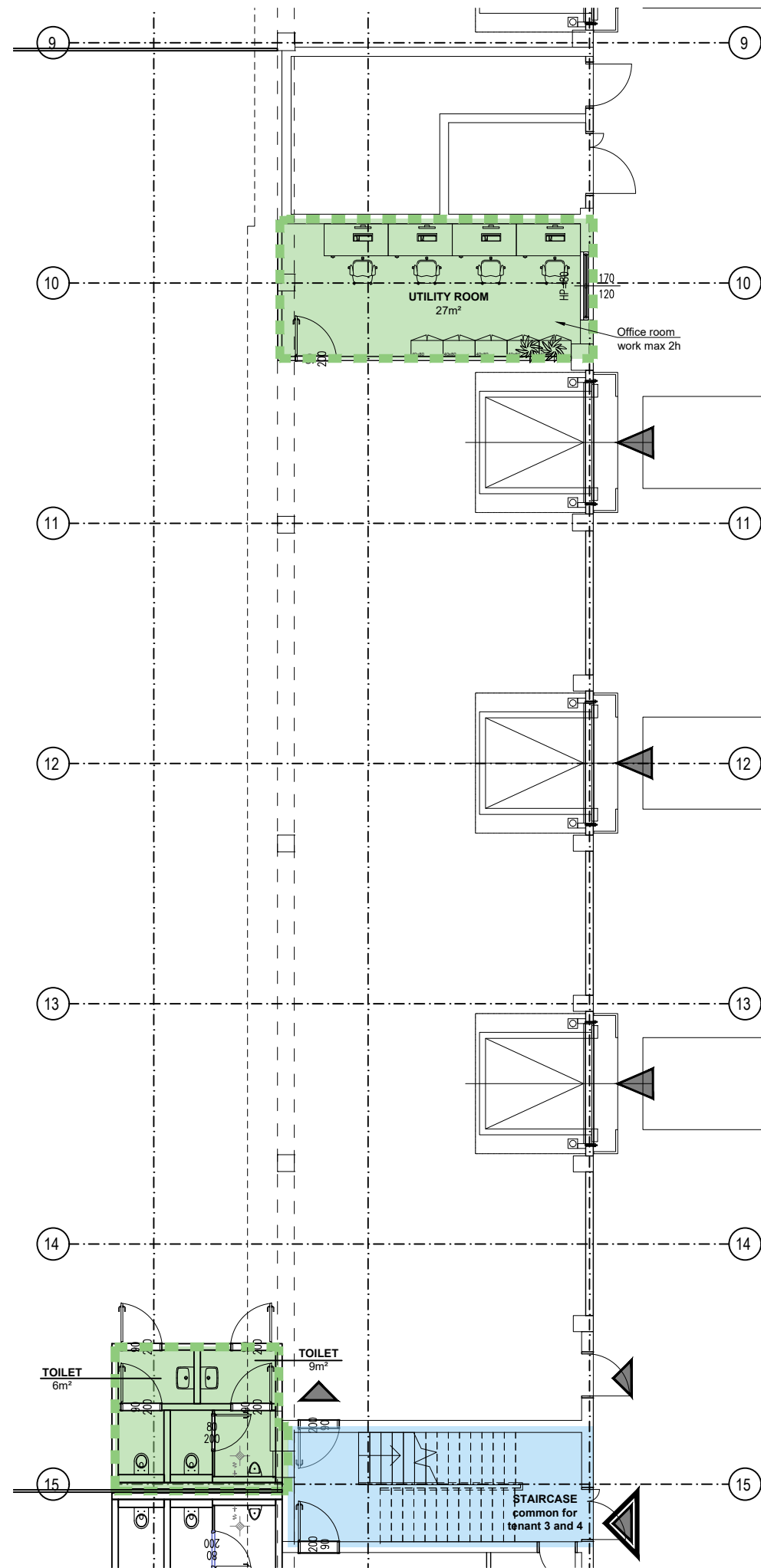

GROUND FLOOR

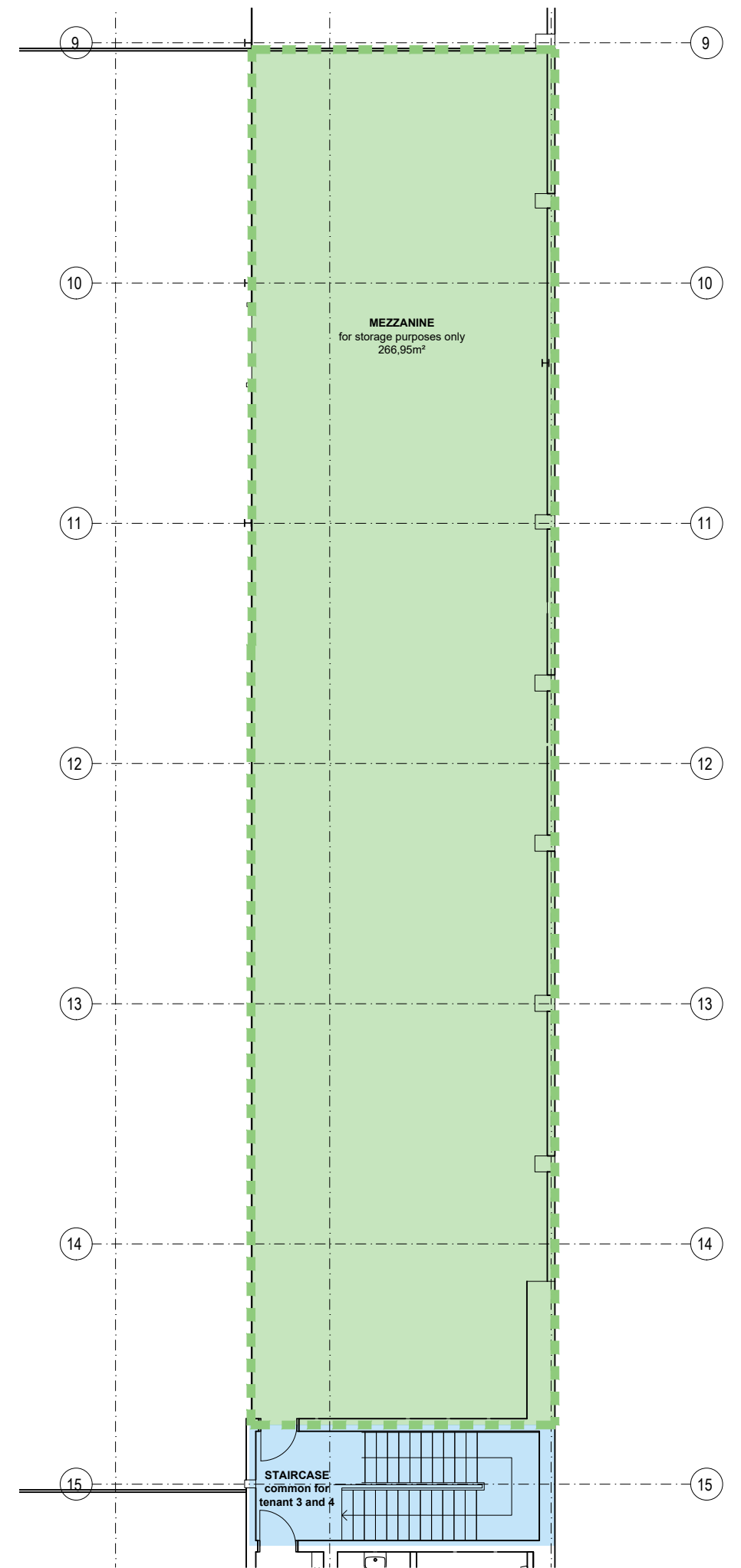

FIRST FLOOR